

$$\underline{\quad} - 32 = 63$$

$$0 + \underline{\quad} = 98$$

$$53 + 40 = \underline{\quad}$$

$$\underline{\quad} - 15 = 38$$

$$1 + \underline{\quad} = 72$$

$$\underline{\quad} - 48 = 13$$

$$6 + 38 = \underline{\quad}$$

$$67 - 33 = \underline{\quad}$$

$$\underline{\quad} - 4 = 52$$

$$\underline{\quad} + 40 = 74$$

$$\underline{\quad} - 34 = 42$$

$$20 + 22 = \underline{\quad}$$

$$67 - \underline{\quad} = 61$$

$$67 + 26 = \underline{\quad}$$

$$17 + \underline{\quad} = 32$$

$$94 - 51 = \underline{\quad}$$

$$76 + \underline{\quad} = 97$$

$$92 - 9 = \underline{\quad}$$

$$66 + \underline{\quad} = 67$$

$$\underline{\quad} - 17 = 60$$

$$71 + 28 = \underline{\quad}$$

$$97 - \underline{\quad} = 35$$

$$\underline{\quad} - 1 = 98$$

$$78 + \underline{\quad} = 85$$

$$\underline{\quad} + 6 = 83$$

$$75 - \underline{\quad} = 13$$

$$80 - 27 = \underline{\quad}$$

$$\underline{\quad} + 21 = 43$$

$$68 + 15 = \underline{\quad}$$

$$51 - 13 = \underline{\quad}$$

$$97 - 95 = \underline{\quad}$$

$$57 + 4 = \underline{\quad}$$

# Kopfrechenheft

im Zahlenraum bis 100

Von



Fehler

$86 + 4 = \underline{\quad}$

$47 + 5 = \underline{\quad}$

$11 + 8 = \underline{\quad}$

$13 + 18 = \underline{\quad}$

$70 + 27 = \underline{\quad}$

$46 + 28 = \underline{\quad}$

$3 + 36 = \underline{\quad}$

$49 + 7 = \underline{\quad}$

$12 + 25 = \underline{\quad}$

$45 + 32 = \underline{\quad}$

$85 + 14 = \underline{\quad}$

$20 + 9 = \underline{\quad}$

$53 + 46 = \underline{\quad}$

$17 + 76 = \underline{\quad}$

$47 + 19 = \underline{\quad}$

$14 + 5 = \underline{\quad}$

$41 + 47 = \underline{\quad}$

$38 + 13 = \underline{\quad}$

$45 + 40 = \underline{\quad}$

$84 + 8 = \underline{\quad}$

$66 + 4 = \underline{\quad}$

$84 + 9 = \underline{\quad}$

$58 + 10 = \underline{\quad}$

$59 + 36 = \underline{\quad}$

$21 + 46 = \underline{\quad}$

$53 + 42 = \underline{\quad}$

$0 + 42 = \underline{\quad}$

$34 + 58 = \underline{\quad}$

$30 + 52 = \underline{\quad}$

$13 + 16 = \underline{\quad}$

$8 + 46 = \underline{\quad}$

$41 + 2 = \underline{\quad}$

$38 + 16 = \underline{\quad}$

$51 - 8 = \underline{\quad}$

$79 + 17 = \underline{\quad}$

$86 - 31 = \underline{\quad}$

$53 + 6 = \underline{\quad}$

$71 - 17 = \underline{\quad}$

$68 - 52 = \underline{\quad}$

$51 + 7 = \underline{\quad}$

$81 + 6 = \underline{\quad}$

$60 - 44 = \underline{\quad}$

$27 + 63 = \underline{\quad}$

$63 - 47 = \underline{\quad}$

$89 + 11 = \underline{\quad}$

$69 - 67 = \underline{\quad}$

$85 - 21 = \underline{\quad}$

$42 + 18 = \underline{\quad}$

$69 - 15 = \underline{\quad}$

$60 + 21 = \underline{\quad}$

$85 - 27 = \underline{\quad}$

$14 + 3 = \underline{\quad}$

$58 + 30 = \underline{\quad}$

$65 - 22 = \underline{\quad}$

$86 + 12 = \underline{\quad}$

$63 - 49 = \underline{\quad}$

$8 + 43 = \underline{\quad}$

$64 - 9 = \underline{\quad}$

$69 + 30 = \underline{\quad}$

$51 - 17 = \underline{\quad}$

$91 - 54 = \underline{\quad}$

$16 + 78 = \underline{\quad}$

$88 + 5 = \underline{\quad}$

$95 - 81 = \underline{\quad}$



Fehler



Fehler

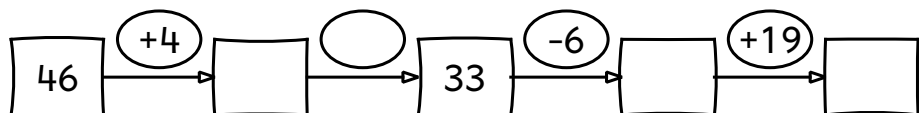
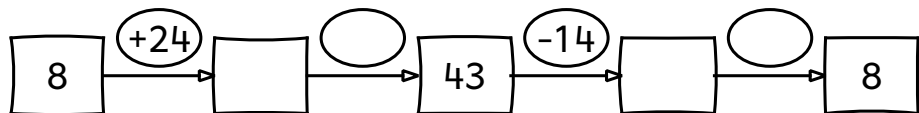
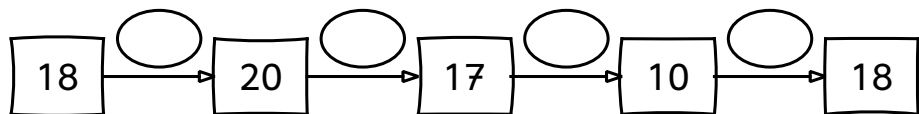
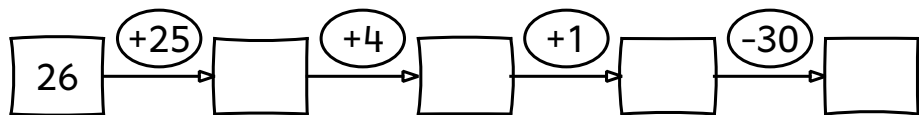
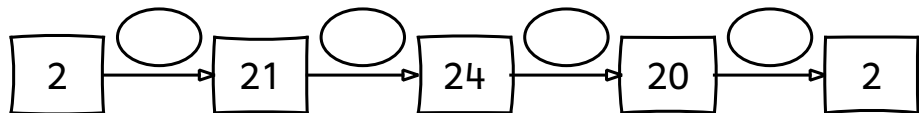
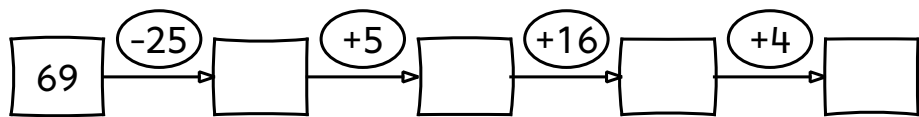

Fehler

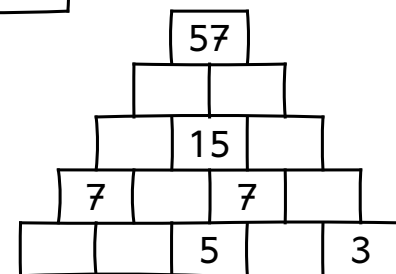
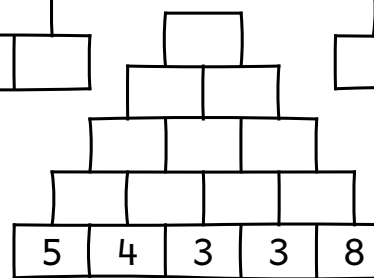
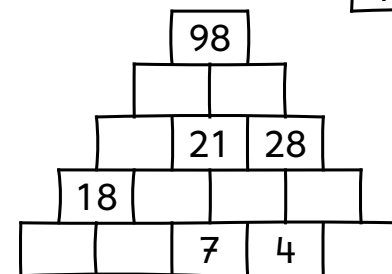
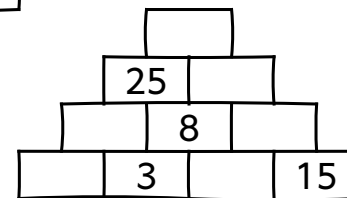
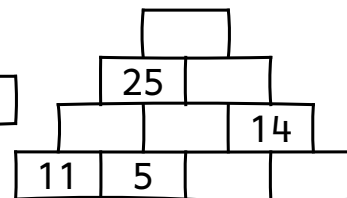
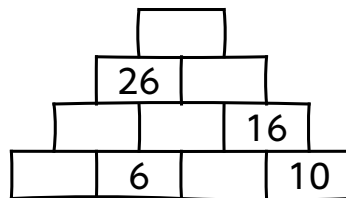
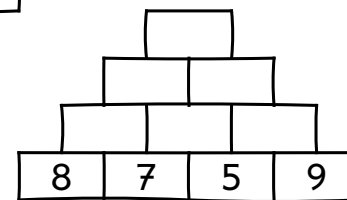
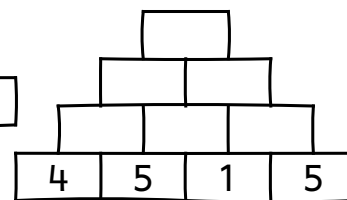
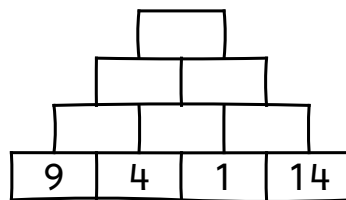
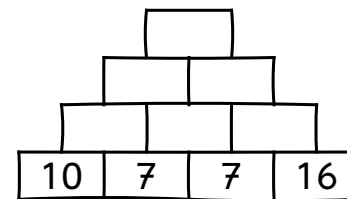
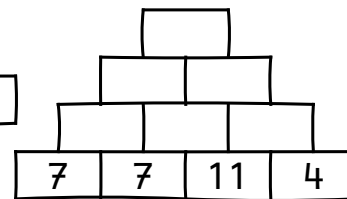
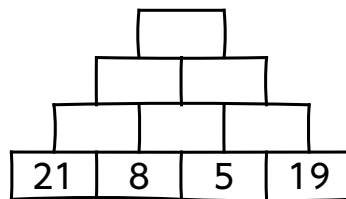

Fehler

$92 - 6 = \underline{\quad}$

$54 - 39 = \underline{\quad}$

$58 - 12 = \underline{\quad}$

$67 - 17 = \underline{\quad}$

$58 - 45 = \underline{\quad}$

$81 - 53 = \underline{\quad}$

$53 - 34 = \underline{\quad}$

$76 - 45 = \underline{\quad}$

$56 - 19 = \underline{\quad}$

$73 - 36 = \underline{\quad}$

$98 - 18 = \underline{\quad}$

$90 - 47 = \underline{\quad}$

$70 - 11 = \underline{\quad}$

$90 - 68 = \underline{\quad}$

$54 - 40 = \underline{\quad}$

$85 - 59 = \underline{\quad}$

$81 - 53 = \underline{\quad}$

$87 - 36 = \underline{\quad}$

$62 - 11 = \underline{\quad}$

$87 - 51 = \underline{\quad}$

$52 - 26 = \underline{\quad}$

$75 - 43 = \underline{\quad}$

$60 - 15 = \underline{\quad}$

$58 - 3 = \underline{\quad}$

$67 - 6 = \underline{\quad}$

$52 - 39 = \underline{\quad}$

$55 - 10 = \underline{\quad}$

$99 - 63 = \underline{\quad}$

$97 - 26 = \underline{\quad}$

$55 - 47 = \underline{\quad}$

$75 - 67 = \underline{\quad}$

$92 - 68 = \underline{\quad}$

$98 - \underline{\quad} = 31$

$83 + \underline{\quad} = 97$

$50 + \underline{\quad} = 61$

$91 - \underline{\quad} = 33$

$52 + \underline{\quad} = 97$

$67 - \underline{\quad} = 26$

$60 - \underline{\quad} = 0$

$56 + \underline{\quad} = 65$

$23 + \underline{\quad} = 31$

$57 - \underline{\quad} = 10$

$33 + \underline{\quad} = 87$

$72 - \underline{\quad} = 18$

$72 + \underline{\quad} = 81$

$53 - \underline{\quad} = 3$

$57 - \underline{\quad} = 50$

$24 + \underline{\quad} = 91$

$21 + \underline{\quad} = 50$

$97 - \underline{\quad} = 49$

$4 + \underline{\quad} = 65$

$97 - \underline{\quad} = 47$

$56 - \underline{\quad} = 17$

$2 + \underline{\quad} = 79$

$80 - \underline{\quad} = 74$

$81 + \underline{\quad} = 85$

$64 - \underline{\quad} = 29$

$57 + \underline{\quad} = 87$

$48 + \underline{\quad} = 52$

$52 - \underline{\quad} = 27$

$66 - \underline{\quad} = 36$

$61 + \underline{\quad} = 73$

$57 + \underline{\quad} = 70$

$89 - \underline{\quad} = 89$



Fehler



Fehler

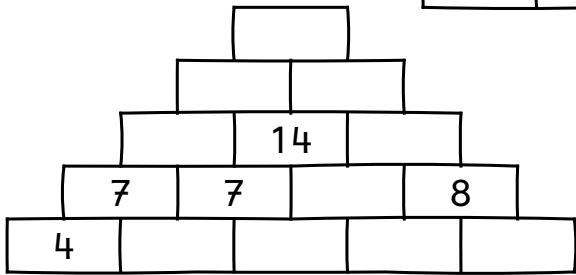
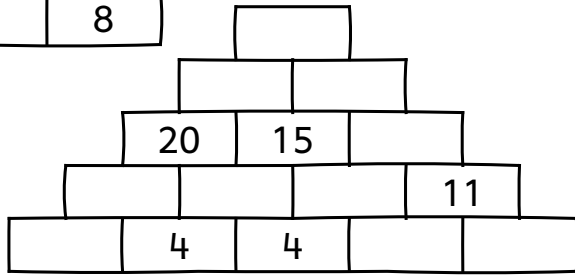
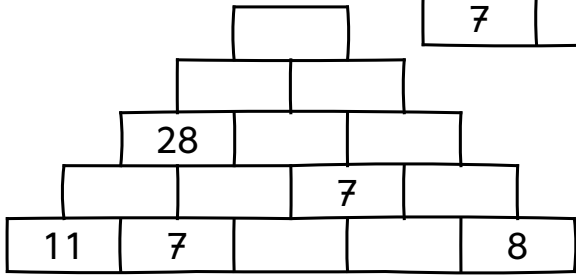
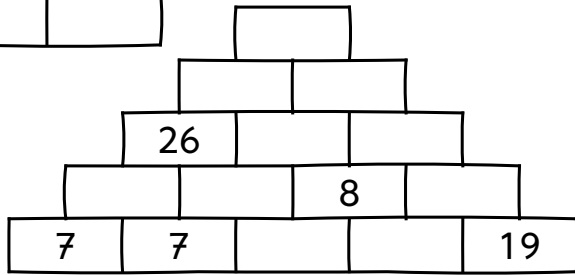
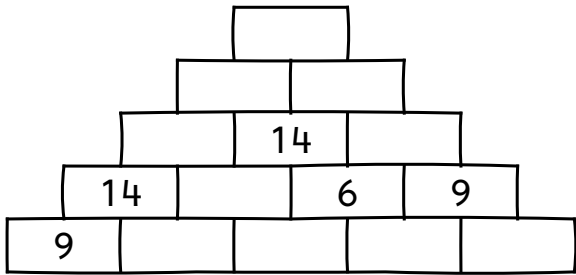

Fehler

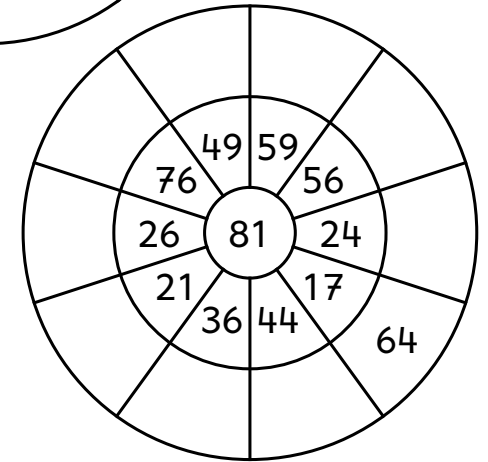
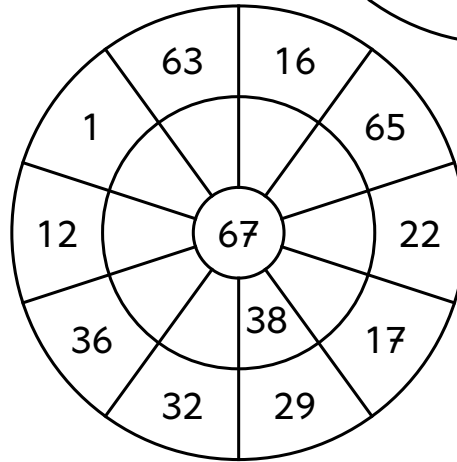
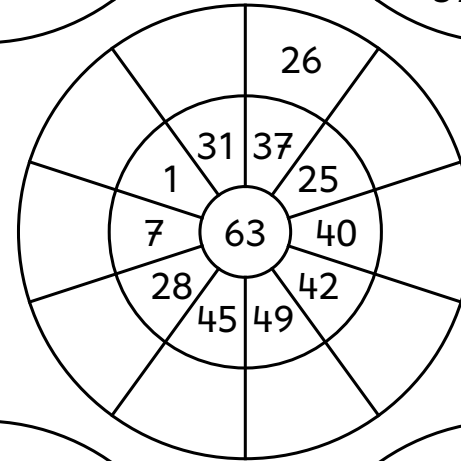
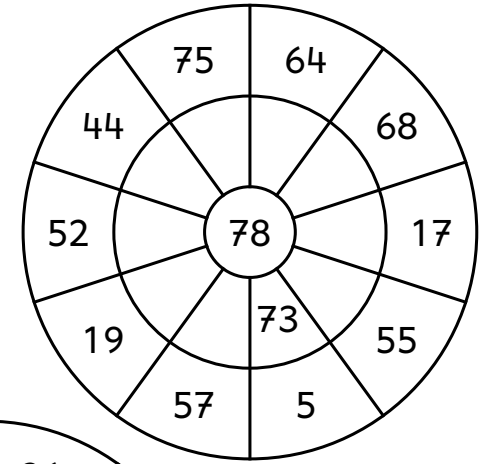
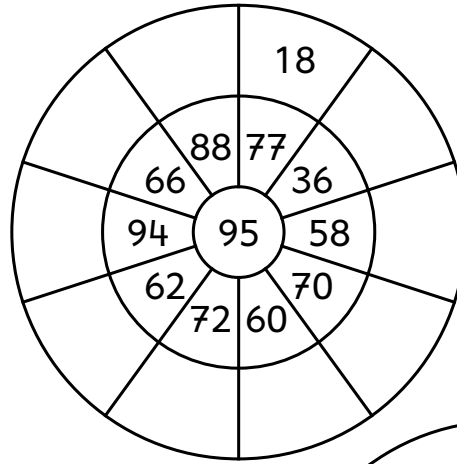

Fehler

$92 - 65 = \underline{\quad}$

$36 + 59 = \underline{\quad}$

$22 + 29 = \underline{\quad}$

$98 - 29 = \underline{\quad}$

$62 - 38 = \underline{\quad}$

$26 + 59 = \underline{\quad}$

$76 + 17 = \underline{\quad}$

$53 - 39 = \underline{\quad}$

$78 + 16 = \underline{\quad}$

$76 - 27 = \underline{\quad}$

$84 - 27 = \underline{\quad}$

$79 + 3 = \underline{\quad}$

$12 + 9 = \underline{\quad}$

$91 - 68 = \underline{\quad}$

$83 + 9 = \underline{\quad}$

$65 - 7 = \underline{\quad}$

$52 - 27 = \underline{\quad}$

$3 + 89 = \underline{\quad}$

$74 + 18 = \underline{\quad}$

$95 - 29 = \underline{\quad}$

$52 + 29 = \underline{\quad}$

$68 - 59 = \underline{\quad}$

$2 + 59 = \underline{\quad}$

$95 - 86 = \underline{\quad}$

$12 + 49 = \underline{\quad}$

$58 - 49 = \underline{\quad}$

$72 - 4 = \underline{\quad}$

$22 + 49 = \underline{\quad}$

$76 - 67 = \underline{\quad}$

$78 + 15 = \underline{\quad}$

$17 + 57 = \underline{\quad}$

$85 - 76 = \underline{\quad}$

$\underline{\quad} + 29 = 58$

$\underline{\quad} + 9 = 97$

$\underline{\quad} + 9 = 91$

$\underline{\quad} + 9 = 62$

$\underline{\quad} + 33 = 51$

$\underline{\quad} + 9 = 83$

$\underline{\quad} + 6 = 85$

$\underline{\quad} + 18 = 53$

$\underline{\quad} + 27 = 94$

$\underline{\quad} + 47 = 51$

$\underline{\quad} + 67 = 82$

$\underline{\quad} + 39 = 51$

$\underline{\quad} + 76 = 83$

$\underline{\quad} + 49 = 71$

$\underline{\quad} + 18 = 82$

$\underline{\quad} + 18 = 96$

$\underline{\quad} + 39 = 58$

$\underline{\quad} + 8 = 17$

$\underline{\quad} + 7 = 71$

$\underline{\quad} + 38 = 51$

$\underline{\quad} + 49 = 61$

$\underline{\quad} + 9 = 61$

$\underline{\quad} + 49 = 81$

$\underline{\quad} + 39 = 97$

$\underline{\quad} + 6 = 93$

$\underline{\quad} + 37 = 92$

$\underline{\quad} + 77 = 81$

$\underline{\quad} + 8 = 87$

$\underline{\quad} + 8 = 44$

$\underline{\quad} + 68 = 94$

$\underline{\quad} + 7 = 93$

$\underline{\quad} + 89 = 96$



Fehler



Fehler

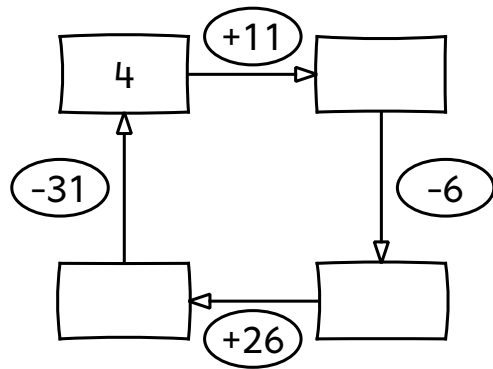
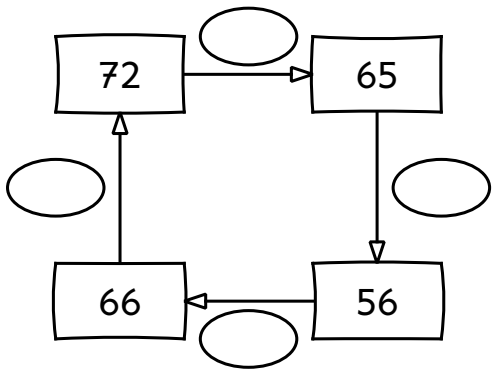
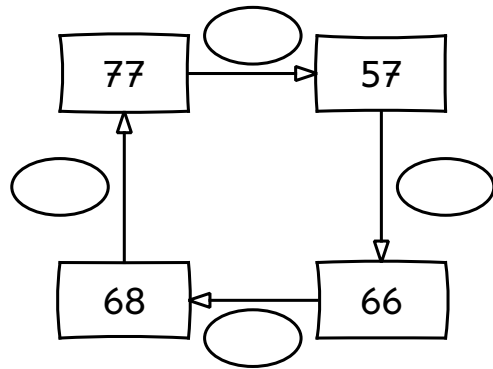
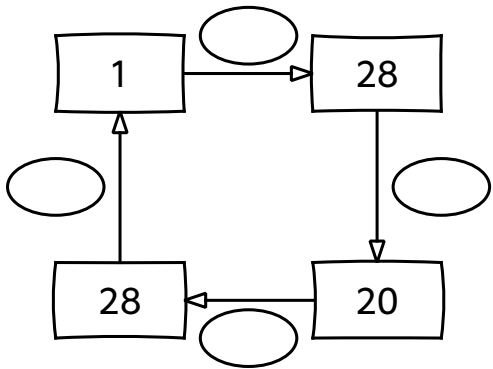
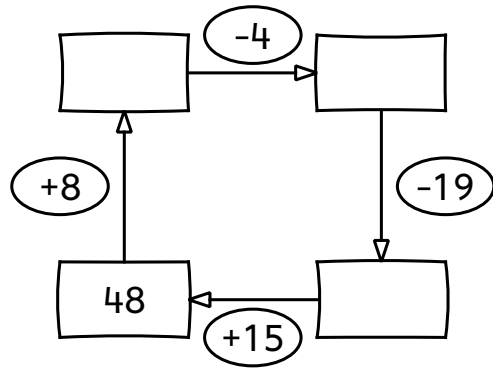
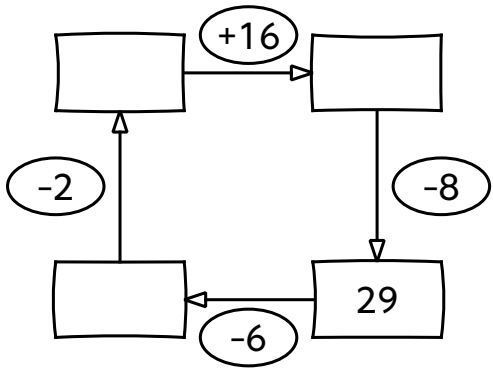

Fehler

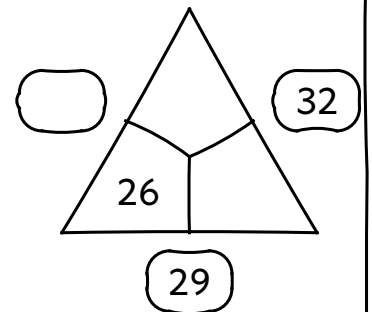
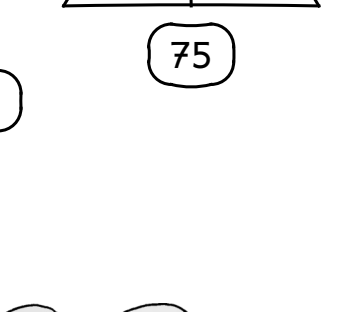
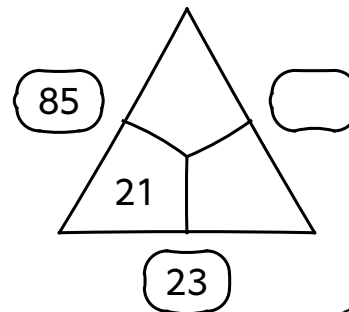
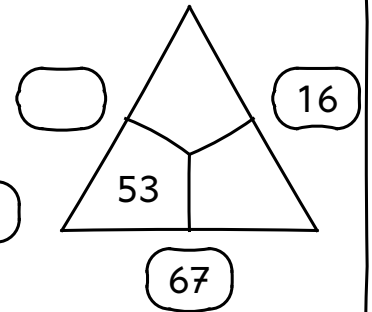
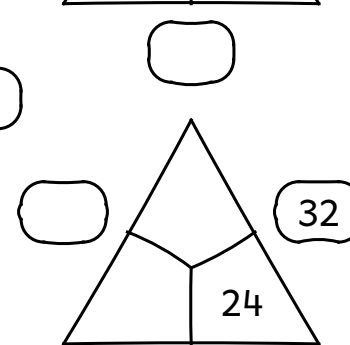
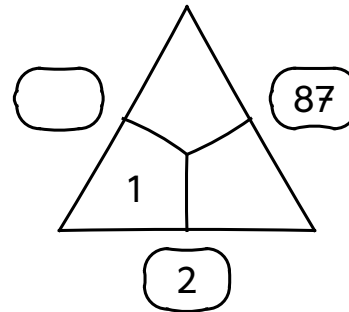
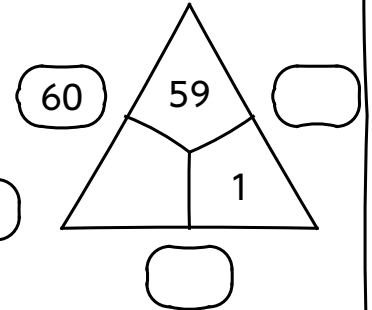
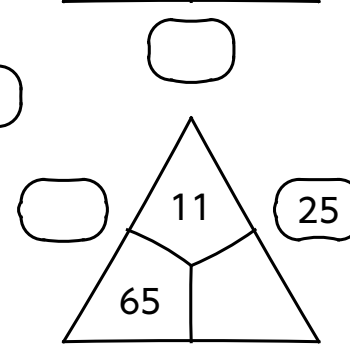
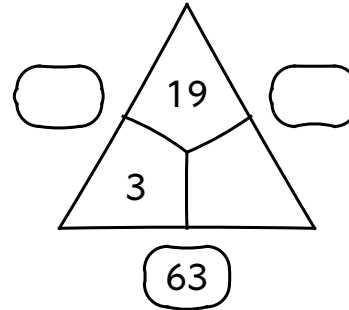
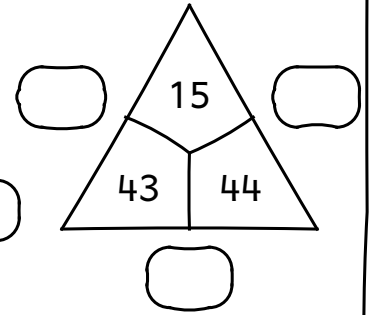
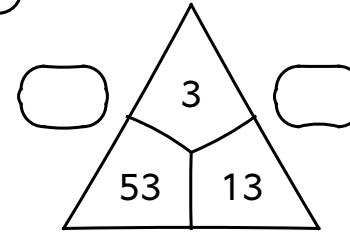
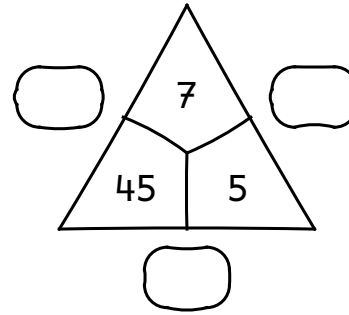

Fehler

$2 + 79 = \underline{\quad}$	$68 - 9 = \underline{\quad}$
$64 - 55 = \underline{\quad}$	$27 + 34 = \underline{\quad}$
$6 + 6 = \underline{\quad}$	$5 + 26 = \underline{\quad}$
$73 - 56 = \underline{\quad}$	$95 - 38 = \underline{\quad}$
$93 - 56 = \underline{\quad}$	$92 - 57 = \underline{\quad}$
$26 + 49 = \underline{\quad}$	$45 + 49 = \underline{\quad}$
$87 - 59 = \underline{\quad}$	$52 - 45 = \underline{\quad}$
$23 + 29 = \underline{\quad}$	$74 + 8 = \underline{\quad}$
$74 - 48 = \underline{\quad}$	$92 - 87 = \underline{\quad}$
$66 + 16 = \underline{\quad}$	$42 + 39 = \underline{\quad}$
$85 + 6 = \underline{\quad}$	$48 + 8 = \underline{\quad}$
$72 - 7 = \underline{\quad}$	$62 - 46 = \underline{\quad}$
$47 + 4 = \underline{\quad}$	$94 - 25 = \underline{\quad}$
$54 - 6 = \underline{\quad}$	$13 + 38 = \underline{\quad}$
$89 + 3 = \underline{\quad}$	$82 - 9 = \underline{\quad}$
$73 - 34 = \underline{\quad}$	$36 + 39 = \underline{\quad}$



Fehler

$69 + 3 = \underline{\quad}$	$76 + \underline{\quad} = 95$
$86 + \underline{\quad} = 95$	$67 + \underline{\quad} = 73$
$46 + 49 = \underline{\quad}$	$6 + 77 = \underline{\quad}$
$\underline{\quad} + 17 = 74$	$76 + 17 = \underline{\quad}$
$12 + 39 = \underline{\quad}$	$58 + 25 = \underline{\quad}$
$\underline{\quad} + 8 = 84$	$19 + \underline{\quad} = 57$
$44 + 48 = \underline{\quad}$	$\underline{\quad} + 59 = 82$
$\underline{\quad} + 25 = 94$	$\underline{\quad} + 19 = 71$
$\underline{\quad} + 8 = 42$	$46 + \underline{\quad} = 83$
$16 + \underline{\quad} = 72$	$\underline{\quad} + 8 = 97$
$\underline{\quad} + 16 = 91$	$\underline{\quad} + 37 = 64$
$74 + \underline{\quad} = 91$	$63 + \underline{\quad} = 92$
$\underline{\quad} + 9 = 97$	$15 + 17 = \underline{\quad}$
$65 + 27 = \underline{\quad}$	$\underline{\quad} + 16 = 81$
$32 + \underline{\quad} = 81$	$\underline{\quad} + 23 = 91$
$\underline{\quad} + 37 = 82$	$34 + 8 = \underline{\quad}$



Fehler



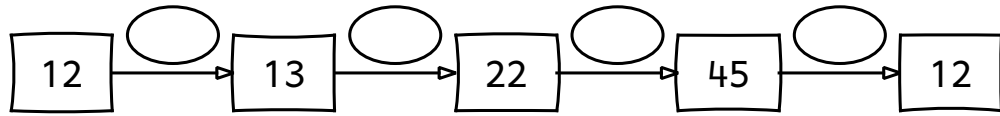
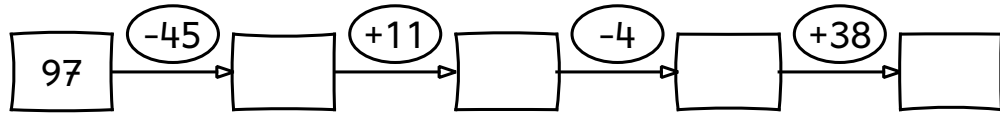
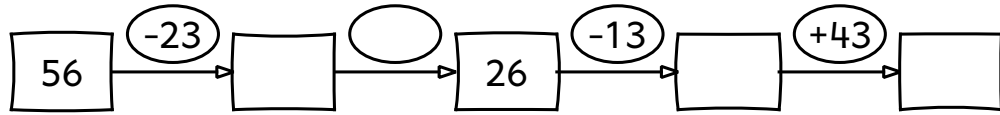
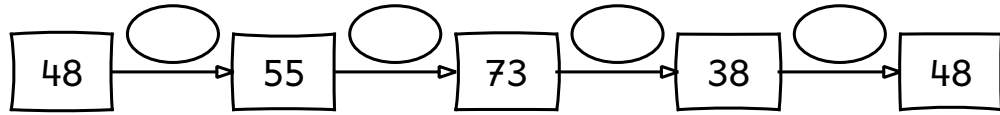
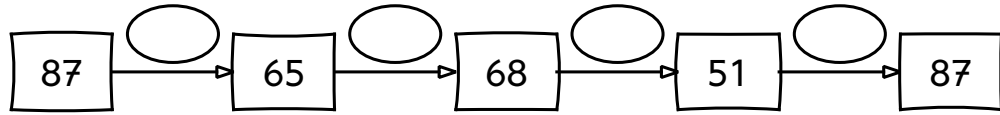
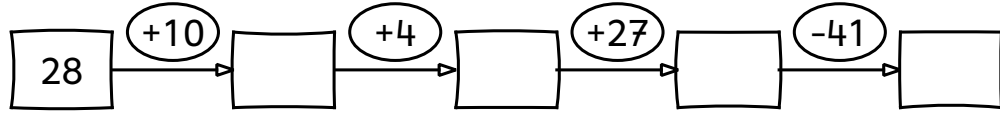
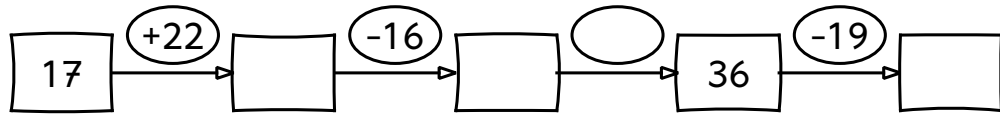

Fehler

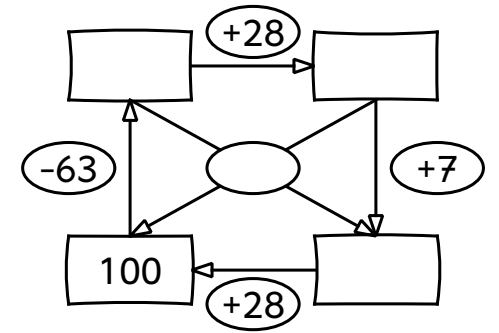
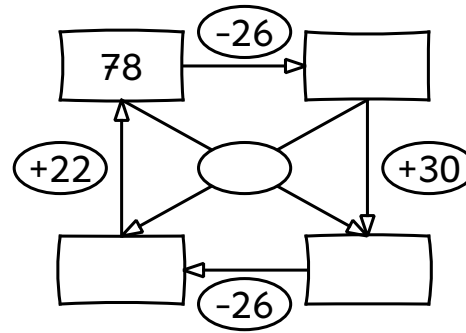
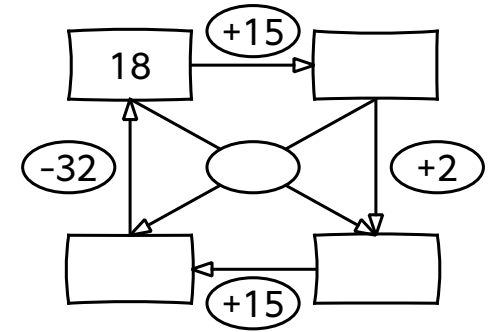
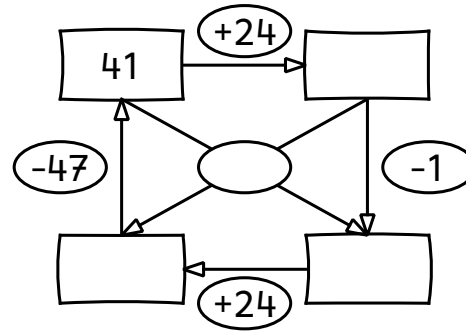
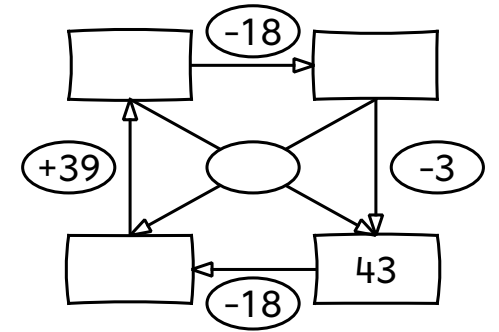
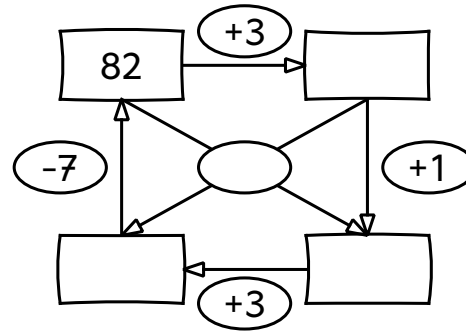

Fehler

$$\underline{\quad} - 13 = 48$$

$$\underline{\quad} + 74 = 91$$

$$\underline{\quad} - 18 = 49$$

$$\underline{\quad} + 26 = 84$$

$$\underline{\quad} + 64 = 92$$

$$\underline{\quad} - 17 = 48$$

$$\underline{\quad} + 7 = 33$$

$$\underline{\quad} - 9 = 49$$

$$\underline{\quad} + 9 = 82$$

$$\underline{\quad} - 15 = 57$$

$$\underline{\quad} + 79 = 92$$

$$\underline{\quad} - 49 = 29$$

$$\underline{\quad} - 68 = 15$$

$$\underline{\quad} + 17 = 83$$

$$\underline{\quad} + 19 = 75$$

$$\underline{\quad} - 74 = 9$$

$$\underline{\quad} - 28 = 58$$

$$\underline{\quad} + 7 = 91$$

$$\underline{\quad} - 27 = 25$$

$$\underline{\quad} + 35 = 84$$

$$\underline{\quad} + 28 = 81$$

$$\underline{\quad} - 17 = 46$$

$$\underline{\quad} + 7 = 22$$

$$\underline{\quad} - 27 = 49$$

$$\underline{\quad} + 17 = 71$$

$$\underline{\quad} - 23 = 68$$

$$\underline{\quad} - 58 = 8$$

$$\underline{\quad} + 6 = 34$$

$$\underline{\quad} - 35 = 19$$

$$\underline{\quad} + 8 = 92$$

$$\underline{\quad} + 5 = 91$$

$$\underline{\quad} - 35 = 17$$

$$14 + 47 = \underline{\quad}$$

$$85 - 78 = \underline{\quad}$$

$$24 + 7 = \underline{\quad}$$

$$87 - 58 = \underline{\quad}$$

$$63 - 29 = \underline{\quad}$$

$$85 + 7 = \underline{\quad}$$

$$71 - 8 = \underline{\quad}$$

$$17 + 64 = \underline{\quad}$$

$$55 - 28 = \underline{\quad}$$

$$26 + 56 = \underline{\quad}$$

$$75 + 7 = \underline{\quad}$$

$$84 - 58 = \underline{\quad}$$

$$83 - 28 = \underline{\quad}$$

$$56 + 37 = \underline{\quad}$$

$$93 - 45 = \underline{\quad}$$

$$52 + 39 = \underline{\quad}$$

$$9 + 25 = \underline{\quad}$$

$$84 - 15 = \underline{\quad}$$

$$43 + 8 = \underline{\quad}$$

$$66 - 9 = \underline{\quad}$$

$$65 + 18 = \underline{\quad}$$

$$66 - 18 = \underline{\quad}$$

$$74 + 18 = \underline{\quad}$$

$$57 - 19 = \underline{\quad}$$

$$15 + 9 = \underline{\quad}$$

$$68 - 39 = \underline{\quad}$$

$$85 - 58 = \underline{\quad}$$

$$46 + 7 = \underline{\quad}$$

$$24 + 18 = \underline{\quad}$$

$$68 - 19 = \underline{\quad}$$

$$78 + 3 = \underline{\quad}$$

$$63 - 59 = \underline{\quad}$$



Fehler



Fehler

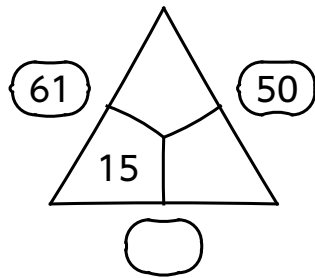
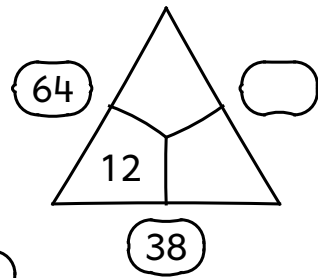
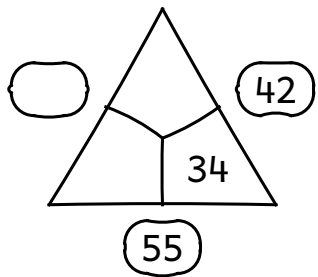
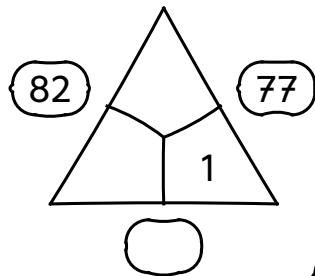
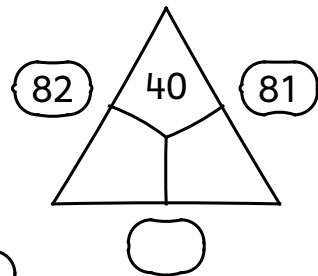
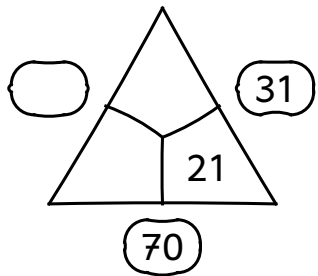
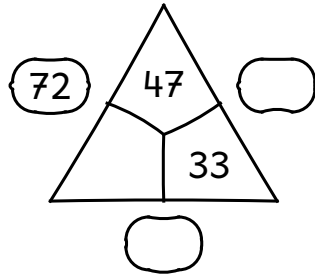
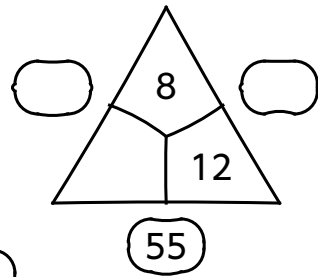
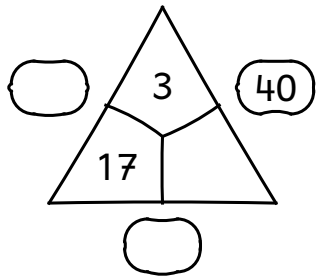

Fehler

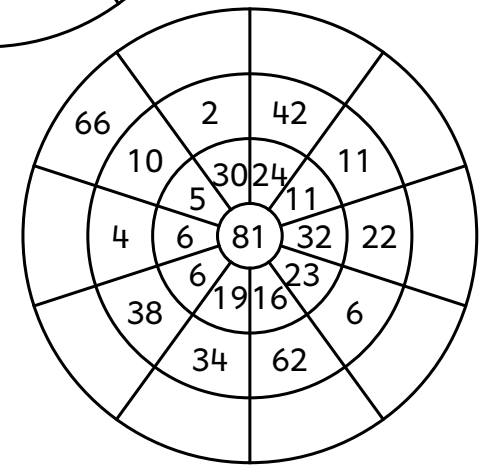
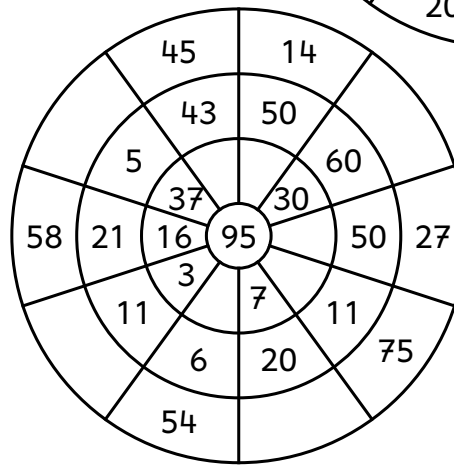
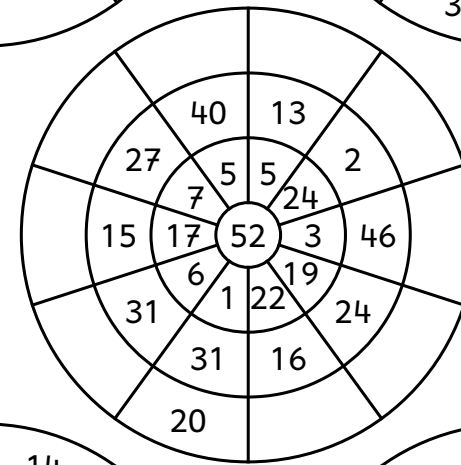
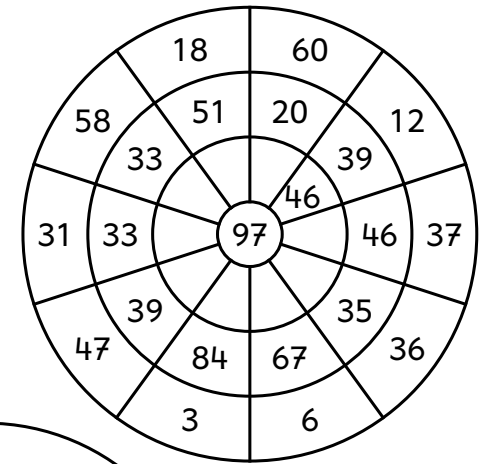
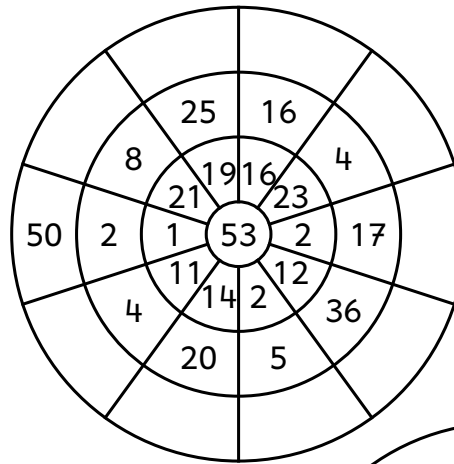

Fehler

$$\underline{\quad} - 39 = 58$$

$$2 + 59 = \underline{\quad}$$

$$\underline{\quad} + 9 = 91$$

$$\underline{\quad} - 57 = 16$$

$$28 + \underline{\quad} = 72$$

$$\underline{\quad} - 48 = 3$$

$$14 + \underline{\quad} = 53$$

$$74 - \underline{\quad} = 25$$

$$\underline{\quad} - 49 = 27$$

$$26 + 36 = \underline{\quad}$$

$$56 - \underline{\quad} = 38$$

$$\underline{\quad} + 25 = 92$$

$$91 - \underline{\quad} = 36$$

$$\underline{\quad} + 9 = 85$$

$$66 + \underline{\quad} = 95$$

$$\underline{\quad} - 68 = 15$$

$$87 + 9 = \underline{\quad}$$

$$\underline{\quad} - 46 = 45$$

$$\underline{\quad} - 29 = 69$$

$$55 + \underline{\quad} = 61$$

$$52 - 13 = \underline{\quad}$$

$$17 + 56 = \underline{\quad}$$

$$57 + \underline{\quad} = 66$$

$$\underline{\quad} - 6 = 69$$

$$62 + 9 = \underline{\quad}$$

$$\underline{\quad} - 22 = 29$$

$$61 - 25 = \underline{\quad}$$

$$\underline{\quad} + 38 = 92$$

$$24 + \underline{\quad} = 91$$

$$63 - \underline{\quad} = 55$$

$$63 + \underline{\quad} = 92$$

$$64 - 28 = \underline{\quad}$$

$$68 - \underline{\quad} = 9$$

$$5 + 39 = \underline{\quad}$$

$$94 - \underline{\quad} = 85$$

$$49 + \underline{\quad} = 73$$

$$47 + \underline{\quad} = 81$$

$$\underline{\quad} - 59 = 17$$

$$14 + 7 = \underline{\quad}$$

$$\underline{\quad} - 38 = 24$$

$$\underline{\quad} - 49 = 27$$

$$\underline{\quad} + 9 = 91$$

$$\underline{\quad} - 48 = 37$$

$$43 + \underline{\quad} = 81$$

$$78 - 29 = \underline{\quad}$$

$$\underline{\quad} + 49 = 61$$

$$\underline{\quad} - 4 = 67$$

$$18 + \underline{\quad} = 62$$

$$69 + 18 = \underline{\quad}$$

$$82 - \underline{\quad} = 74$$

$$54 + 27 = \underline{\quad}$$

$$67 - \underline{\quad} = 18$$

$$\underline{\quad} - 28 = 29$$

$$47 + 24 = \underline{\quad}$$

$$\underline{\quad} - 88 = 9$$

$$19 + 43 = \underline{\quad}$$

$$58 - \underline{\quad} = 49$$

$$29 + \underline{\quad} = 63$$

$$\underline{\quad} - 49 = 12$$

$$36 + \underline{\quad} = 42$$

$$72 - 19 = \underline{\quad}$$

$$\underline{\quad} + 8 = 67$$

$$\underline{\quad} + 36 = 93$$

$$72 - 29 = \underline{\quad}$$



Fehler



Fehler

[www.diegrundschultante.blogspot.de](http://www.diegrundschultante.blogspot.de)

Schrift: Gruschudru basic, KG Second Chance Sketch

erstellt mit: Worksheet Crafter

$95 - 32 = 63$

$0 + 98 = 98$

$53 + 40 = 93$

$53 - 15 = 38$

$1 + 71 = 72$

$61 - 48 = 13$

$6 + 38 = 44$

$67 - 33 = 34$

$56 - 4 = 52$

$34 + 40 = 74$

$76 - 34 = 42$

$20 + 22 = 42$

$67 - 6 = 61$

$67 + 26 = 93$

$17 + 15 = 32$

$94 - 51 = 43$

$76 + 21 = 97$

$92 - 9 = 83$

$66 + 1 = 67$

$77 - 17 = 60$

$71 + 28 = 99$

$97 - 62 = 35$

$99 - 1 = 98$

$78 + 7 = 85$

$77 + 6 = 83$

$75 - 62 = 13$

$80 - 27 = 53$

$22 + 21 = 43$

$68 + 15 = 83$

$51 - 13 = 38$

$97 - 95 = 2$

$57 + 4 = 61$

# Kopfrechenheft

im Zahlenraum bis 100

Von



Fehler

$86 + 4 = \underline{90}$

$47 + 5 = \underline{52}$

$11 + 8 = \underline{19}$

$13 + 18 = \underline{31}$

$70 + 27 = \underline{97}$

$46 + 28 = \underline{74}$

$3 + 36 = \underline{39}$

$49 + 7 = \underline{56}$

$12 + 25 = \underline{37}$

$45 + 32 = \underline{77}$

$85 + 14 = \underline{99}$

$20 + 9 = \underline{29}$

$53 + 46 = \underline{99}$

$17 + 76 = \underline{93}$

$47 + 19 = \underline{66}$

$14 + 5 = \underline{19}$

$41 + 47 = \underline{88}$

$38 + 13 = \underline{51}$

$45 + 40 = \underline{85}$

$84 + 8 = \underline{92}$

$66 + 4 = \underline{70}$

$84 + 9 = \underline{93}$

$58 + 10 = \underline{68}$

$59 + 36 = \underline{95}$

$21 + 46 = \underline{67}$

$53 + 42 = \underline{95}$

$0 + 42 = \underline{42}$

$34 + 58 = \underline{92}$

$30 + 52 = \underline{82}$

$13 + 16 = \underline{29}$

$8 + 46 = \underline{54}$

$41 + 2 = \underline{43}$

$38 + 16 = \underline{54}$

$51 - 8 = \underline{43}$

$79 + 17 = \underline{96}$

$86 - 31 = \underline{55}$

$53 + 6 = \underline{59}$

$71 - 17 = \underline{54}$

$68 - 52 = \underline{16}$

$51 + 7 = \underline{58}$

$81 + 6 = \underline{87}$

$60 - 44 = \underline{16}$

$27 + 63 = \underline{90}$

$63 - 47 = \underline{16}$

$89 + 11 = \underline{100}$

$69 - 67 = \underline{2}$

$85 - 21 = \underline{64}$

$42 + 18 = \underline{60}$

$69 - 15 = \underline{54}$

$60 + 21 = \underline{81}$

$85 - 27 = \underline{58}$

$14 + 3 = \underline{17}$

$58 + 30 = \underline{88}$

$65 - 22 = \underline{43}$

$86 + 12 = \underline{98}$

$63 - 49 = \underline{14}$

$8 + 43 = \underline{51}$

$64 - 9 = \underline{55}$

$69 + 30 = \underline{99}$

$51 - 17 = \underline{34}$

$91 - 54 = \underline{37}$

$16 + 78 = \underline{94}$

$88 + 5 = \underline{93}$

$95 - 81 = \underline{14}$



Fehler



Fehler

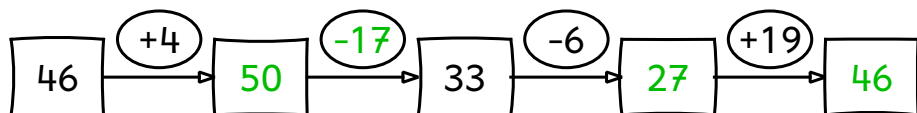
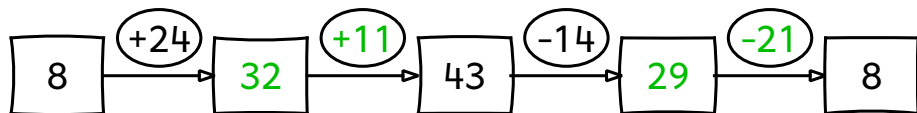
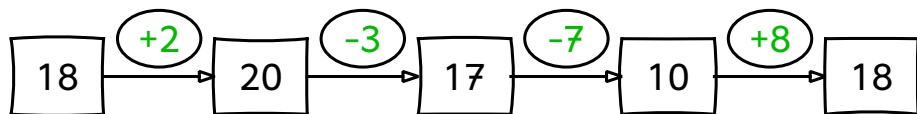
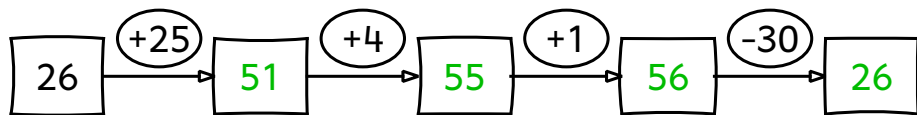
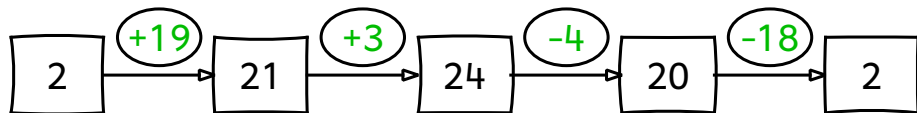

Fehler

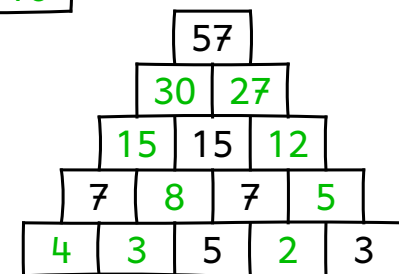
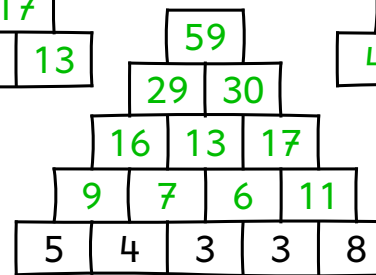
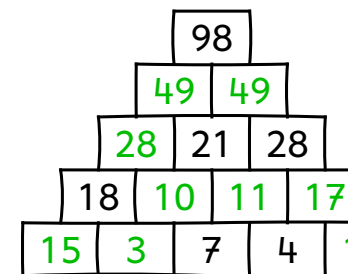
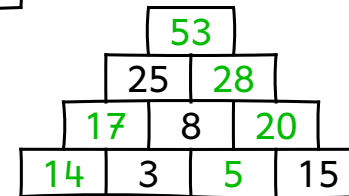
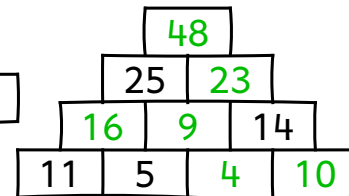
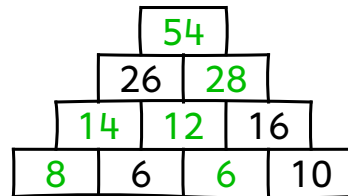
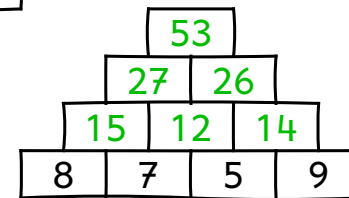
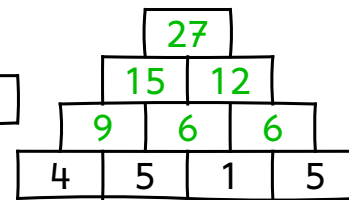
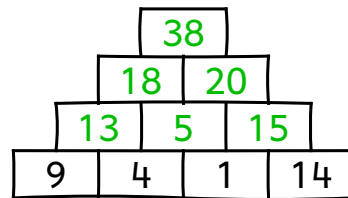
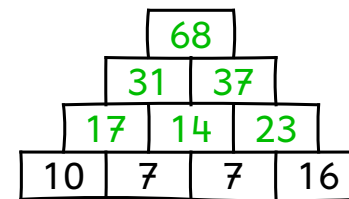
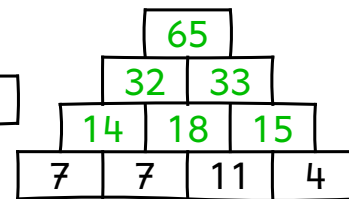
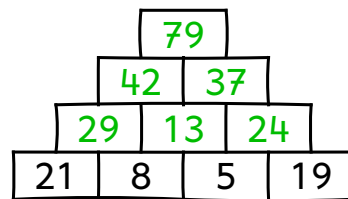

Fehler



$92 - 6 = \underline{86}$

$54 - 39 = \underline{15}$

$58 - 12 = \underline{46}$

$67 - 17 = \underline{50}$

$58 - 45 = \underline{13}$

$81 - 53 = \underline{28}$

$53 - 34 = \underline{19}$

$76 - 45 = \underline{31}$

$56 - 19 = \underline{37}$

$73 - 36 = \underline{37}$

$98 - 18 = \underline{80}$

$90 - 47 = \underline{43}$

$70 - 11 = \underline{59}$

$90 - 68 = \underline{22}$

$54 - 40 = \underline{14}$

$85 - 59 = \underline{26}$

$81 - 53 = \underline{28}$

$87 - 36 = \underline{51}$

$62 - 11 = \underline{51}$

$87 - 51 = \underline{36}$

$52 - 26 = \underline{26}$

$75 - 43 = \underline{32}$

$60 - 15 = \underline{45}$

$58 - 3 = \underline{55}$

$67 - 6 = \underline{61}$

$52 - 39 = \underline{13}$

$55 - 10 = \underline{45}$

$99 - 63 = \underline{36}$

$97 - 26 = \underline{71}$

$55 - 47 = \underline{8}$

$75 - 67 = \underline{8}$

$92 - 68 = \underline{24}$

$98 - \underline{67} = 31$

$83 + \underline{14} = 97$

$50 + \underline{11} = 61$

$91 - \underline{58} = 33$

$52 + \underline{45} = 97$

$67 - \underline{41} = 26$

$60 - \underline{60} = 0$

$56 + \underline{9} = 65$

$23 + \underline{8} = 31$

$57 - \underline{47} = 10$

$33 + \underline{54} = 87$

$72 - \underline{54} = 18$

$72 + \underline{9} = 81$

$53 - \underline{50} = 3$

$57 - \underline{7} = 50$

$24 + \underline{67} = 91$

$21 + \underline{29} = 50$

$97 - \underline{48} = 49$

$4 + \underline{61} = 65$

$97 - \underline{50} = 47$

$56 - \underline{39} = 17$

$2 + \underline{77} = 79$

$80 - \underline{6} = 74$

$81 + \underline{4} = 85$

$64 - \underline{35} = 29$

$57 + \underline{30} = 87$

$48 + \underline{4} = 52$

$52 - \underline{25} = 27$

$66 - \underline{30} = 36$

$61 + \underline{12} = 73$

$57 + \underline{13} = 70$

$89 - \underline{0} = 89$



Fehler



Fehler

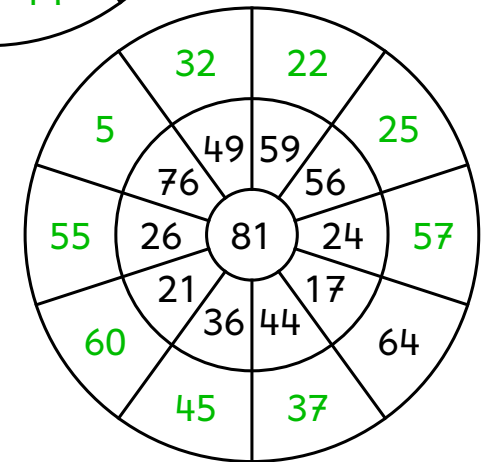
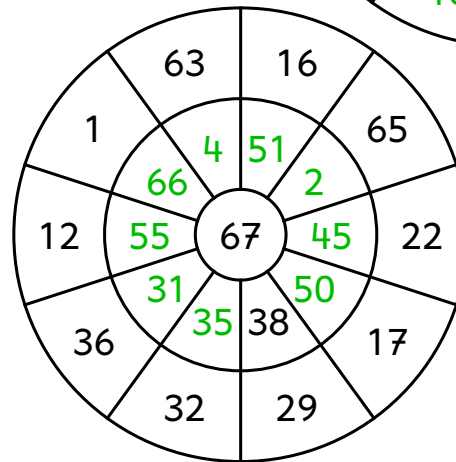
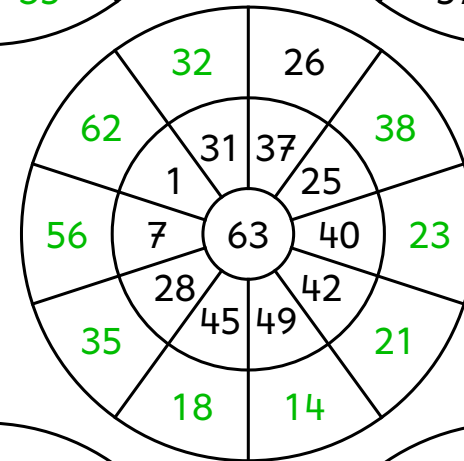
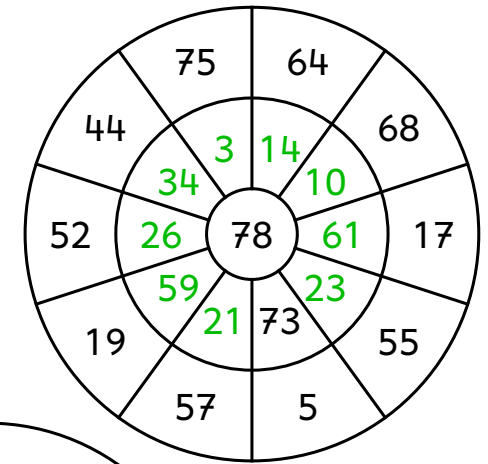
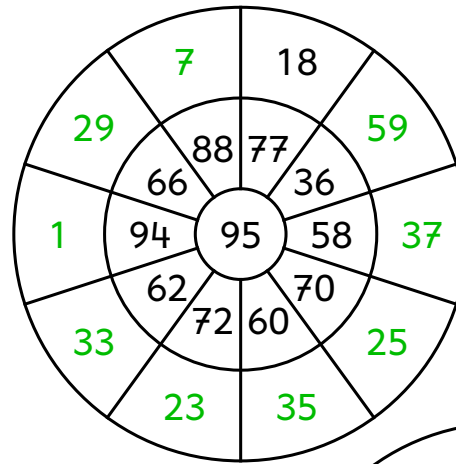
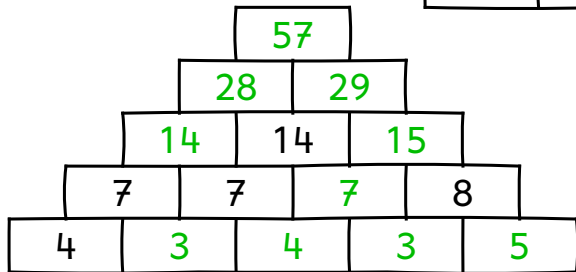
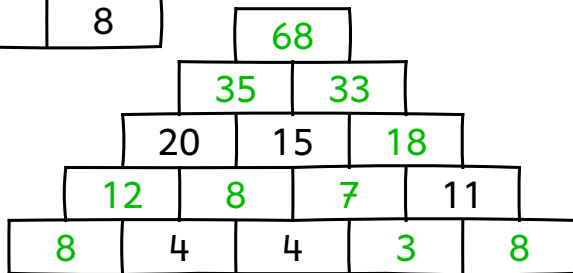
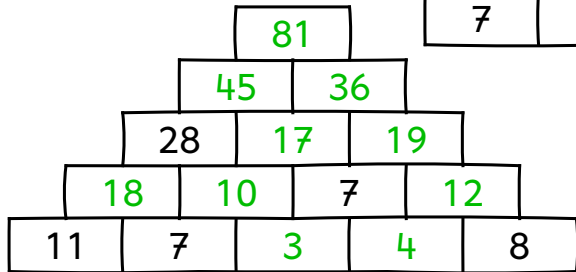
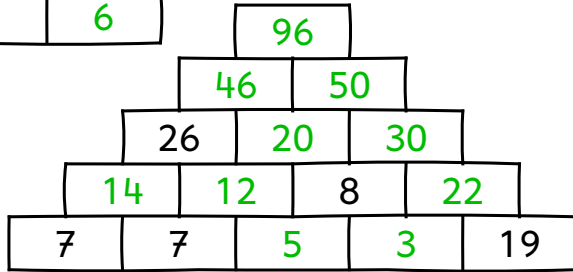
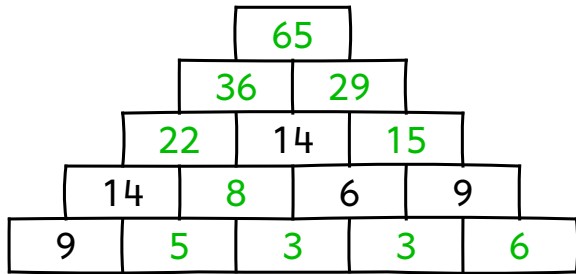

$92 - 65 = \underline{27}$

$36 + 59 = \underline{95}$

$22 + 29 = \underline{51}$

$98 - 29 = \underline{69}$

$62 - 38 = \underline{24}$

$26 + 59 = \underline{85}$

$76 + 17 = \underline{93}$

$53 - 39 = \underline{14}$

$78 + 16 = \underline{94}$

$76 - 27 = \underline{49}$

$84 - 27 = \underline{57}$

$79 + 3 = \underline{82}$

$12 + 9 = \underline{21}$

$91 - 68 = \underline{23}$

$83 + 9 = \underline{92}$

$65 - 7 = \underline{58}$

$52 - 27 = \underline{25}$

$3 + 89 = \underline{92}$

$74 + 18 = \underline{92}$

$95 - 29 = \underline{66}$

$52 + 29 = \underline{81}$

$68 - 59 = \underline{9}$

$2 + 59 = \underline{61}$

$95 - 86 = \underline{9}$

$12 + 49 = \underline{61}$

$58 - 49 = \underline{9}$

$72 - 4 = \underline{68}$

$22 + 49 = \underline{71}$

$76 - 67 = \underline{9}$

$78 + 15 = \underline{93}$

$17 + 57 = \underline{74}$

$85 - 76 = \underline{9}$

$\underline{29} + 29 = 58$

$\underline{88} + 9 = 97$

$\underline{82} + 9 = 91$

$\underline{53} + 9 = 62$

$\underline{18} + 33 = 51$

$\underline{74} + 9 = 83$

$\underline{79} + 6 = 85$

$\underline{35} + 18 = 53$

$\underline{67} + 27 = 94$

$\underline{4} + 47 = 51$

$\underline{15} + 67 = 82$

$\underline{12} + 39 = 51$

$\underline{7} + 76 = 83$

$\underline{22} + 49 = 71$

$\underline{64} + 18 = 82$

$\underline{78} + 18 = 96$

$\underline{19} + 39 = 58$

$\underline{9} + 8 = 17$

$\underline{64} + 7 = 71$

$\underline{13} + 38 = 51$

$\underline{12} + 49 = 61$

$\underline{52} + 9 = 61$

$\underline{32} + 49 = 81$

$\underline{58} + 39 = 97$

$\underline{87} + 6 = 93$

$\underline{55} + 37 = 92$

$\underline{4} + 77 = 81$

$\underline{79} + 8 = 87$

$\underline{36} + 8 = 44$

$\underline{26} + 68 = 94$

$\underline{86} + 7 = 93$

$\underline{7} + 89 = 96$



Fehler



Fehler

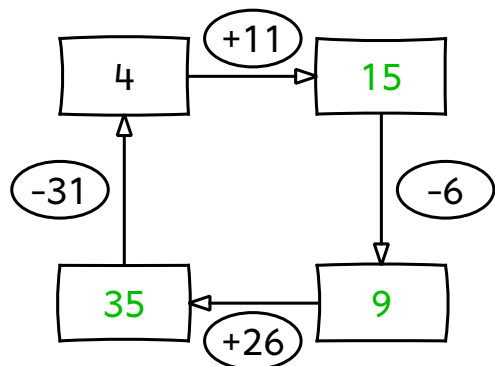
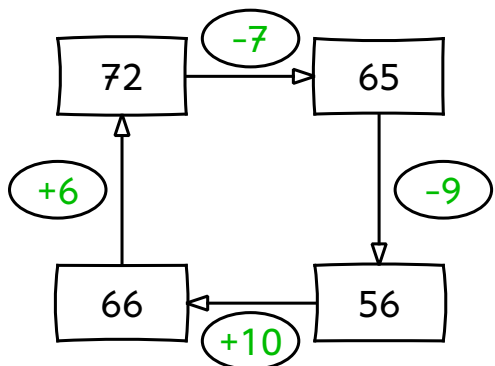
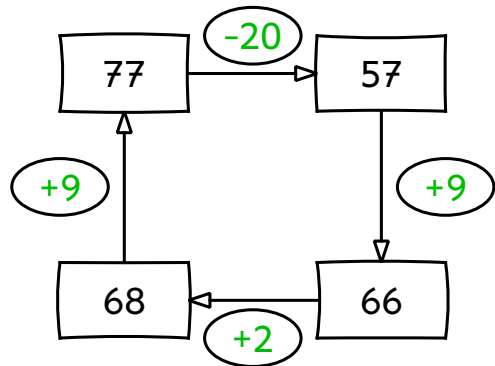
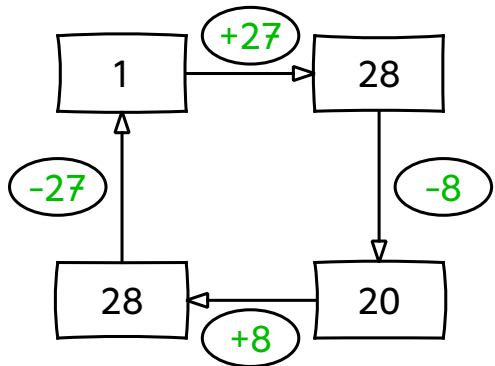
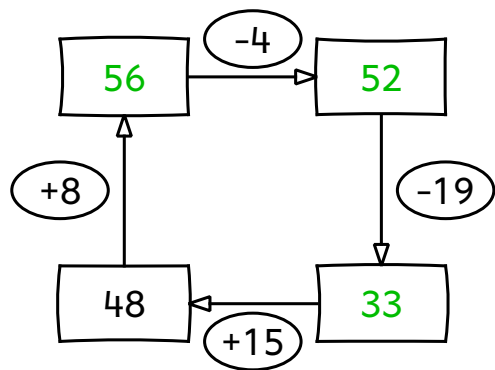
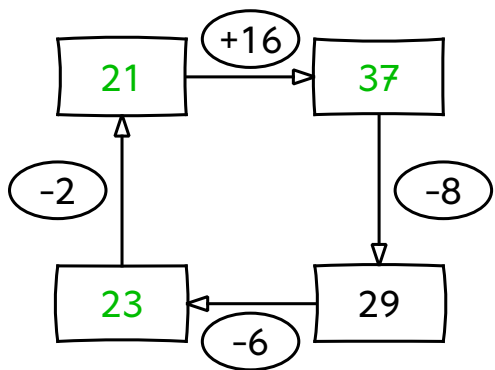

Fehler

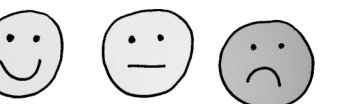
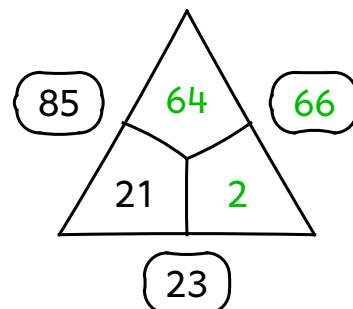
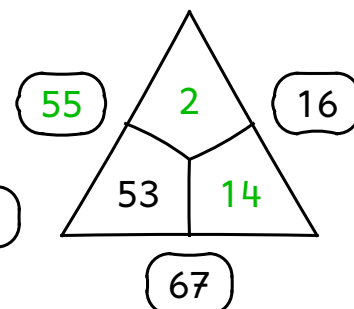
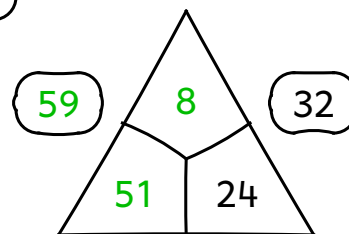
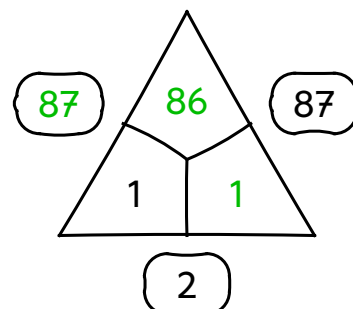
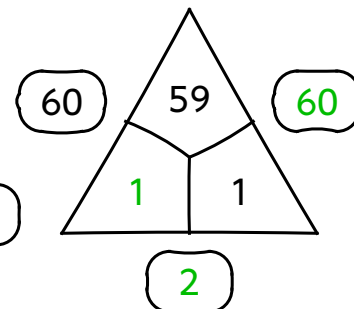
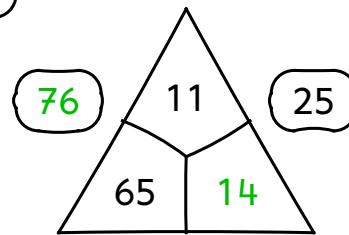
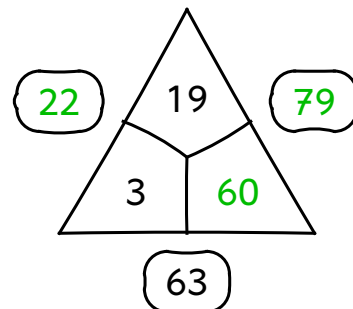
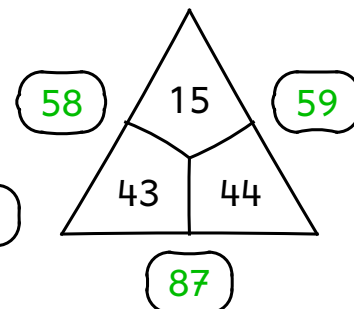
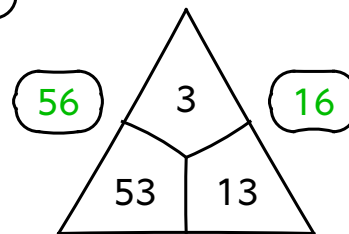
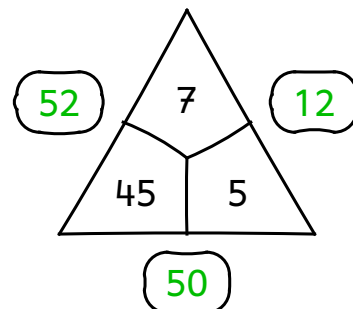

Fehler

$2 + 79 = \underline{81}$	$68 - 9 = \underline{59}$
$64 - 55 = \underline{9}$	$27 + 34 = \underline{61}$
$6 + 6 = \underline{12}$	$5 + 26 = \underline{31}$
$73 - 56 = \underline{17}$	$95 - 38 = \underline{57}$
$93 - 56 = \underline{37}$	$92 - 57 = \underline{35}$
$26 + 49 = \underline{75}$	$45 + 49 = \underline{94}$
$87 - 59 = \underline{28}$	$52 - 45 = \underline{7}$
$23 + 29 = \underline{52}$	$74 + 8 = \underline{82}$
$74 - 48 = \underline{26}$	$92 - 87 = \underline{5}$
$66 + 16 = \underline{82}$	$42 + 39 = \underline{81}$
$85 + 6 = \underline{91}$	$48 + 8 = \underline{56}$
$72 - 7 = \underline{65}$	$62 - 46 = \underline{16}$
$47 + 4 = \underline{51}$	$94 - 25 = \underline{69}$
$54 - 6 = \underline{48}$	$13 + 38 = \underline{51}$
$89 + 3 = \underline{92}$	$82 - 9 = \underline{73}$
$73 - 34 = \underline{39}$	$36 + 39 = \underline{75}$



Fehler

$69 + 3 = \underline{72}$	$76 + \underline{19} = 95$
$86 + \underline{9} = 95$	$67 + \underline{6} = 73$
$46 + 49 = \underline{95}$	$6 + 77 = \underline{83}$
$\underline{57} + 17 = 74$	$76 + 17 = \underline{93}$
$12 + 39 = \underline{51}$	$58 + 25 = \underline{83}$
$\underline{76} + 8 = 84$	$19 + \underline{38} = 57$
$44 + 48 = \underline{92}$	$\underline{23} + 59 = 82$
$\underline{69} + 25 = 94$	$\underline{52} + 19 = 71$
$\underline{34} + 8 = 42$	$46 + \underline{37} = 83$
$16 + \underline{56} = 72$	$\underline{89} + 8 = 97$
$\underline{75} + 16 = 91$	$\underline{27} + 37 = 64$
$74 + \underline{17} = 91$	$63 + \underline{29} = 92$
$\underline{88} + 9 = 97$	$15 + 17 = \underline{32}$
$65 + 27 = \underline{92}$	$\underline{65} + 16 = 81$
$32 + \underline{49} = 81$	$\underline{68} + 23 = 91$
$\underline{45} + 37 = 82$	$34 + 8 = \underline{42}$



Fehler

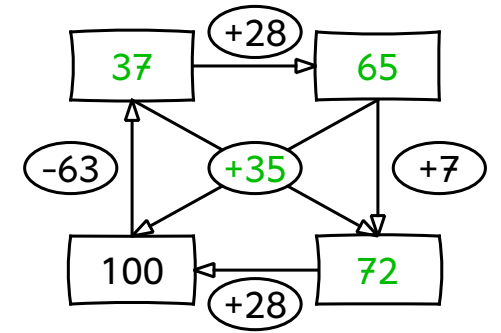
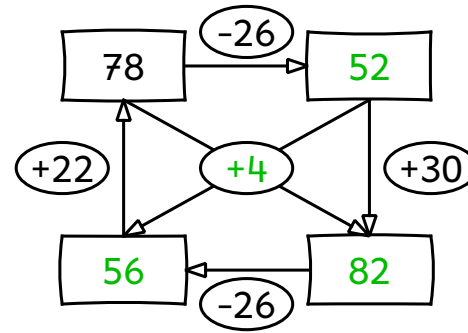
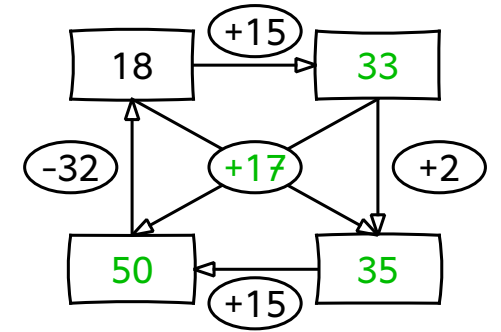
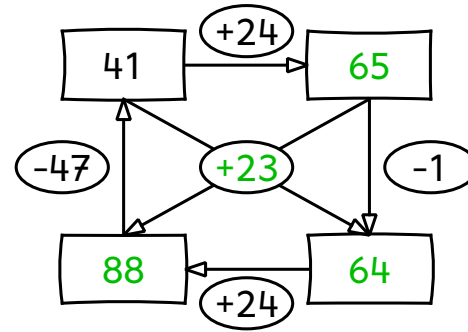
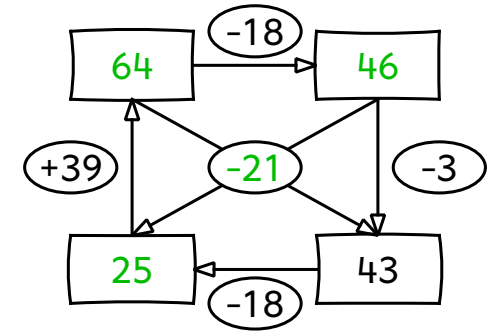
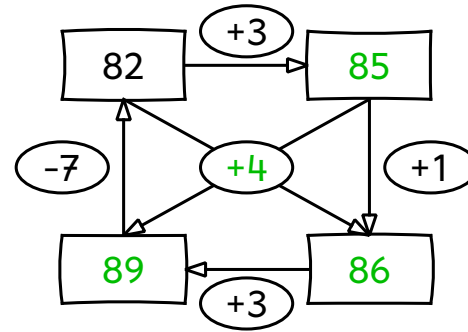
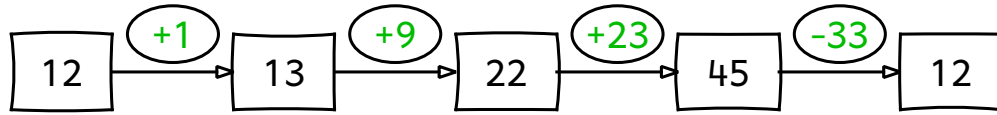
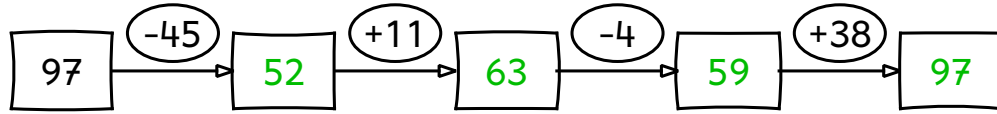
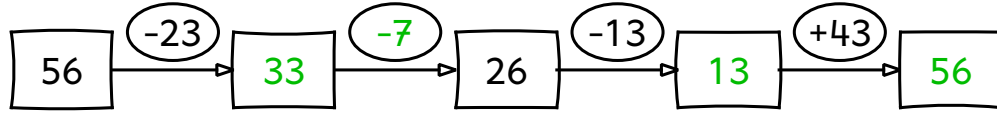
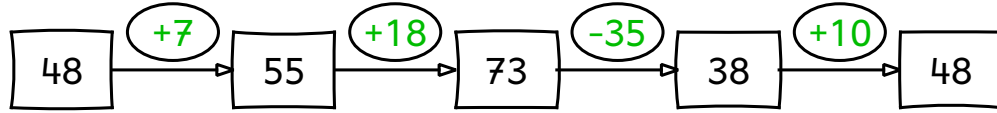
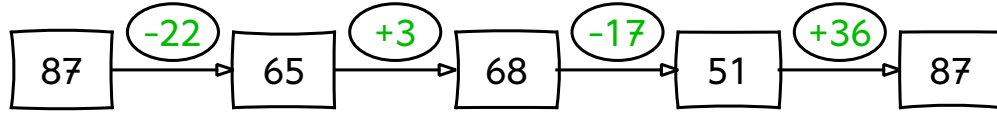
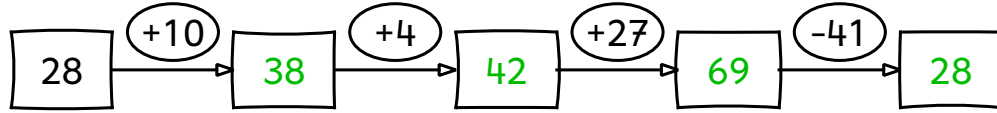
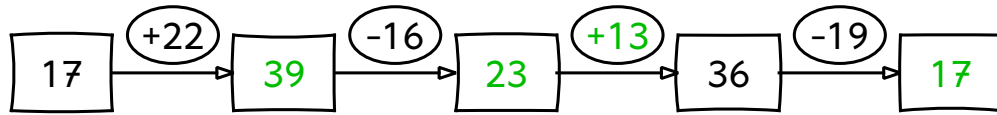

$$\underline{61} - 13 = 48$$

$$\underline{17} + 74 = 91$$

$$\underline{67} - 18 = 49$$

$$\underline{58} + 26 = 84$$

$$\underline{28} + 64 = 92$$

$$\underline{65} - 17 = 48$$

$$\underline{26} + 7 = 33$$

$$\underline{58} - 9 = 49$$

$$\underline{73} + 9 = 82$$

$$\underline{72} - 15 = 57$$

$$\underline{13} + 79 = 92$$

$$\underline{78} - 49 = 29$$

$$\underline{83} - 68 = 15$$

$$\underline{66} + 17 = 83$$

$$\underline{56} + 19 = 75$$

$$\underline{83} - 74 = 9$$

$$\underline{86} - 28 = 58$$

$$\underline{84} + 7 = 91$$

$$\underline{52} - 27 = 25$$

$$\underline{49} + 35 = 84$$

$$\underline{53} + 28 = 81$$

$$\underline{63} - 17 = 46$$

$$\underline{15} + 7 = 22$$

$$\underline{76} - 27 = 49$$

$$\underline{54} + 17 = 71$$

$$\underline{91} - 23 = 68$$

$$\underline{66} - 58 = 8$$

$$\underline{28} + 6 = 34$$

$$\underline{54} - 35 = 19$$

$$\underline{84} + 8 = 92$$

$$\underline{86} + 5 = 91$$

$$\underline{52} - 35 = 17$$

$$14 + 47 = \underline{61}$$

$$85 - 78 = \underline{7}$$

$$24 + 7 = \underline{31}$$

$$87 - 58 = \underline{29}$$

$$63 - 29 = \underline{34}$$

$$85 + 7 = \underline{92}$$

$$71 - 8 = \underline{63}$$

$$17 + 64 = \underline{81}$$

$$55 - 28 = \underline{27}$$

$$26 + 56 = \underline{82}$$

$$75 + 7 = \underline{82}$$

$$84 - 58 = \underline{26}$$

$$83 - 28 = \underline{55}$$

$$56 + 37 = \underline{93}$$

$$93 - 45 = \underline{48}$$

$$52 + 39 = \underline{91}$$

$$9 + 25 = \underline{34}$$

$$84 - 15 = \underline{69}$$

$$43 + 8 = \underline{51}$$

$$66 - 9 = \underline{57}$$

$$65 + 18 = \underline{83}$$

$$66 - 18 = \underline{48}$$

$$74 + 18 = \underline{92}$$

$$57 - 19 = \underline{38}$$

$$15 + 9 = \underline{24}$$

$$68 - 39 = \underline{29}$$

$$85 - 58 = \underline{27}$$

$$46 + 7 = \underline{53}$$

$$24 + 18 = \underline{42}$$

$$68 - 19 = \underline{49}$$

$$78 + 3 = \underline{81}$$

$$63 - 59 = \underline{4}$$



Fehler



Fehler

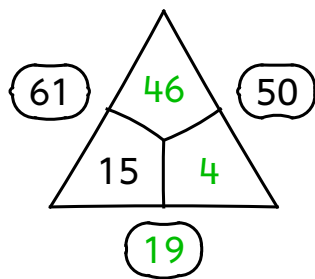
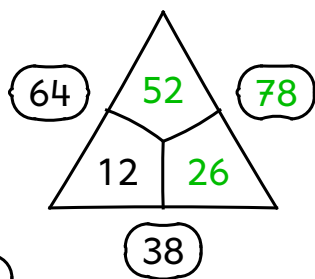
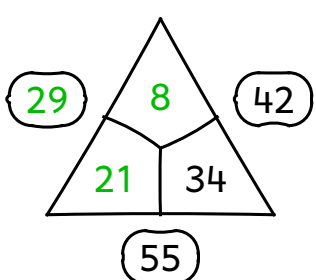
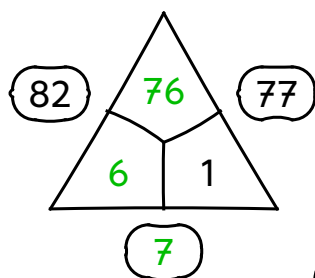
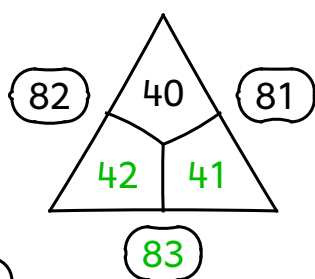
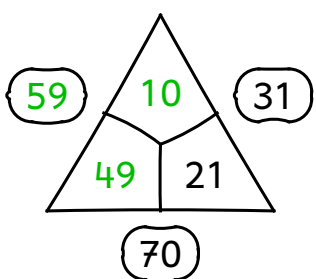
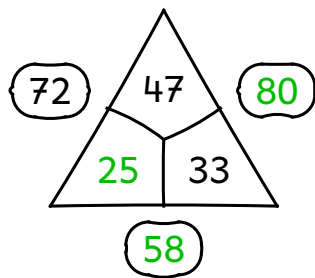
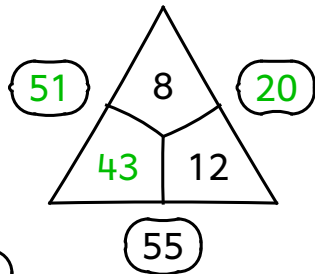
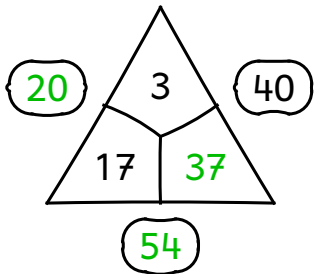

Fehler

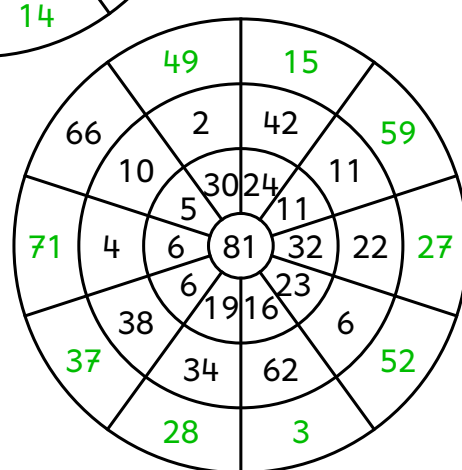
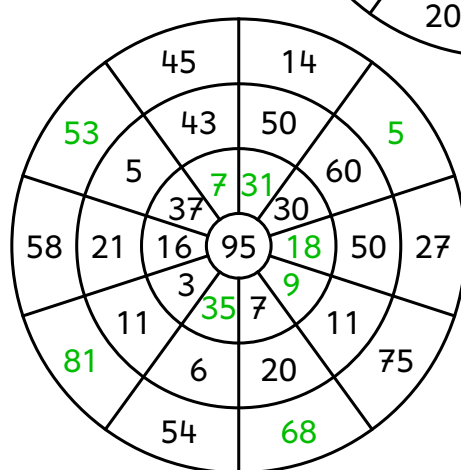
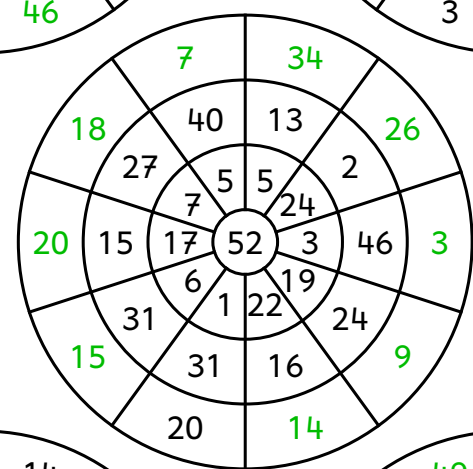
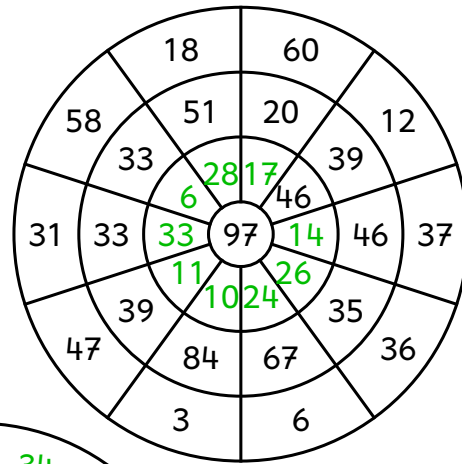
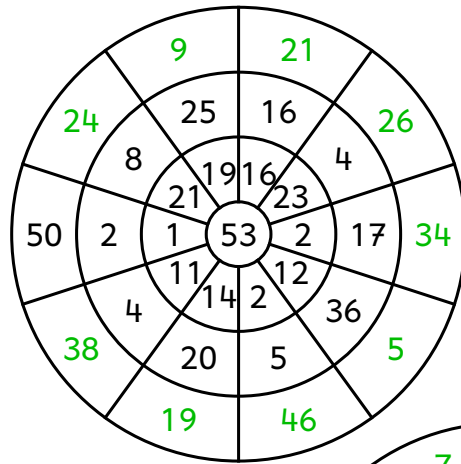

Fehler



$$\underline{97} - 39 = 58$$

$$2 + 59 = \underline{61}$$

$$\underline{82} + 9 = 91$$

$$\underline{73} - 57 = 16$$

$$28 + \underline{44} = 72$$

$$\underline{51} - 48 = 3$$

$$14 + \underline{39} = 53$$

$$74 - \underline{49} = 25$$

$$\underline{76} - 49 = 27$$

$$26 + 36 = \underline{62}$$

$$56 - \underline{18} = 38$$

$$\underline{67} + 25 = 92$$

$$91 - \underline{55} = 36$$

$$\underline{76} + 9 = 85$$

$$66 + \underline{29} = 95$$

$$\underline{83} - 68 = 15$$

$$87 + 9 = \underline{96}$$

$$\underline{91} - 46 = 45$$

$$\underline{98} - 29 = 69$$

$$55 + \underline{6} = 61$$

$$52 - 13 = \underline{39}$$

$$17 + 56 = \underline{73}$$

$$57 + \underline{9} = 66$$

$$\underline{75} - 6 = 69$$

$$62 + 9 = \underline{71}$$

$$\underline{51} - 22 = 29$$

$$61 - 25 = \underline{36}$$

$$\underline{54} + 38 = 92$$

$$24 + \underline{67} = 91$$

$$63 - \underline{8} = 55$$

$$63 + \underline{29} = 92$$

$$64 - 28 = \underline{36}$$

$$68 - \underline{59} = 9$$

$$5 + 39 = \underline{44}$$

$$94 - \underline{9} = 85$$

$$49 + \underline{24} = 73$$

$$47 + \underline{34} = 81$$

$$\underline{76} - 59 = 17$$

$$14 + 7 = \underline{21}$$

$$\underline{62} - 38 = 24$$

$$\underline{76} - 49 = 27$$

$$\underline{82} + 9 = 91$$

$$\underline{85} - 48 = 37$$

$$43 + \underline{38} = 81$$

$$78 - 29 = \underline{49}$$

$$\underline{12} + 49 = 61$$

$$\underline{71} - 4 = 67$$

$$18 + \underline{44} = 62$$

$$69 + 18 = \underline{87}$$

$$82 - \underline{8} = 74$$

$$54 + 27 = \underline{81}$$

$$67 - \underline{49} = 18$$

$$\underline{57} - 28 = 29$$

$$47 + 24 = \underline{71}$$

$$\underline{97} - 88 = 9$$

$$19 + 43 = \underline{62}$$

$$58 - \underline{9} = 49$$

$$29 + \underline{34} = 63$$

$$\underline{61} - 49 = 12$$

$$36 + \underline{6} = 42$$

$$72 - 19 = \underline{53}$$

$$\underline{59} + 8 = 67$$

$$\underline{57} + 36 = 93$$

$$72 - 29 = \underline{43}$$



Fehler



Fehler

[www.diegrundschultante.blogspot.de](http://www.diegrundschultante.blogspot.de)

Schrift: Gruschudru basic, KG Second Chance Sketch

erstellt mit: Worksheet Crafter